

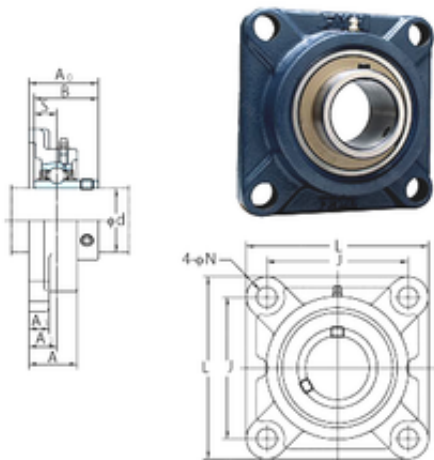

NTN Bearing Driveshaft do Brasil



FYH UCF209-28 bearing units

Bearing No. UCF209-28

Bore Diameter	44,45 mm
d	44,45 mm
A0	52,2 mm
A	38 mm
A1	16 mm
B	49,2 mm
J	105 mm
L	137 mm
N	16 mm
S	19 mm
Bolt (G)	M14
A2	22 mm
Weight	2,2 Kg
Basic dynamic load rating (C)	34,1 kN
Basic static load rating (C0)	21,3 kN

UCF209-28 Bearing 2D drawings and 3D CAD models